



AMG

reach up and touch the sky

AMG ELEVATOR

**ELEVATOR
CONSTRUCTORS
SCHEME**

WWW.AMGELEVATOR.COM

COMPACT MACHINE ROOM ELEVATORS

SHAFT PLAN

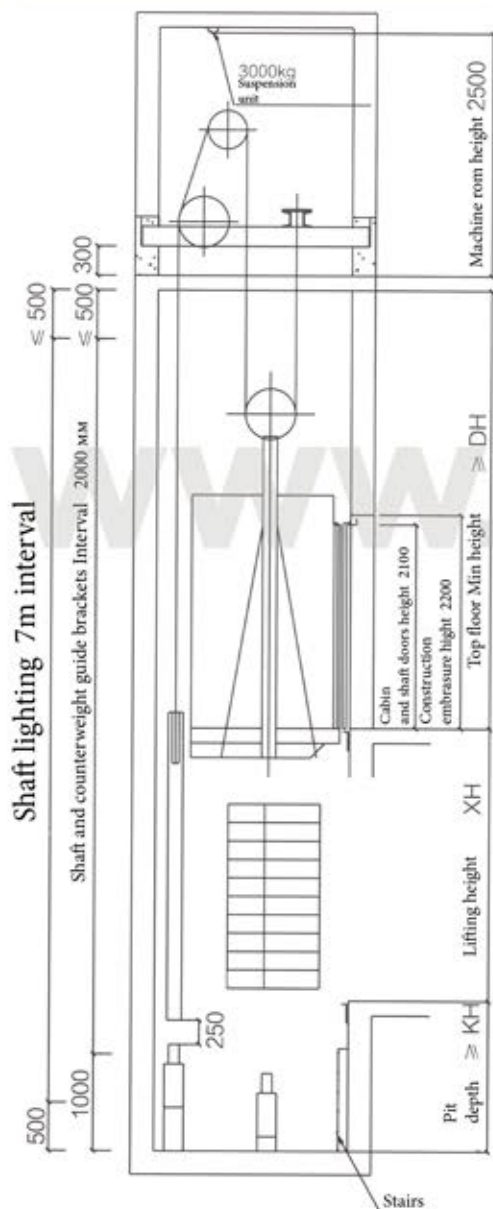

SHAFT DRAFT

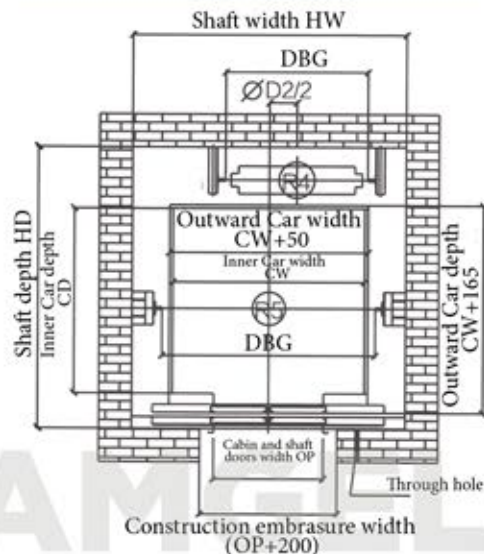

MACHINE ROOM DRAFT

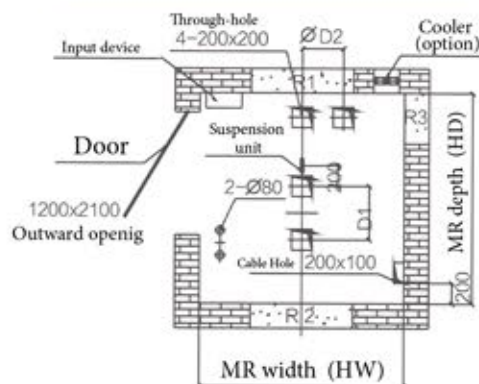

MACHINE ROOM SCHEME

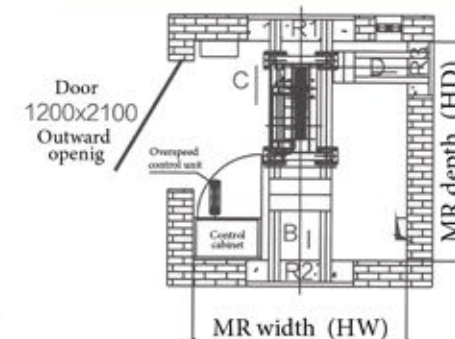

Model	Capacity, kg/passengers	Car dimension	Doors opening type	Door Opening Width	Shaft dimension	Max. area, sq.m.
AMG PMR450	450x6	1200x1050x2500	Center	800x2100	1800x1800	1,3
AMG PMR630	630x8	1400x1100x2500	Center	800x2100	2000x1800	1,66
AMG PMR800	800x10	1400x1350x2500	Center	800x2100	2000x2050	2
AMG PMR825	825x11	1400x1400x2500	Center	800x2100	2000x2050	2,05
AMG PMR1000	1000x13	1600x1450x2500	Center	900x2100	2200x2200	2,4
AMG PMR1050	1050x14	1600x1500x2500	Center	900x2100	2200x2200	2,5
AMG PMR1150	1150x15	1700x1500x2500	Center	1000x2100	2300x2200	2,7
AMG PMR1350	1350x18	1850x1600x2500	Center	1100x2100	2450x2400	3,1
AMG PMR1600	1600x21	2000x1700x2500	Center	1100x2100	2600x2500	3,56

SHAFT PLAN

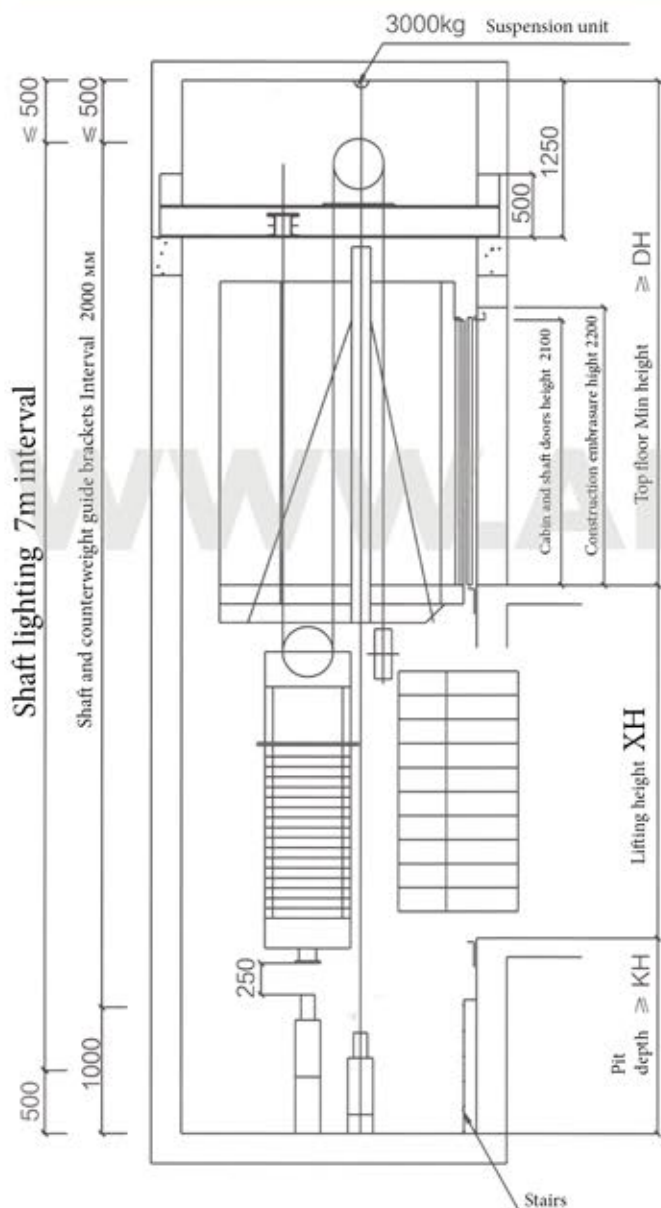

SHAFT DRAFT

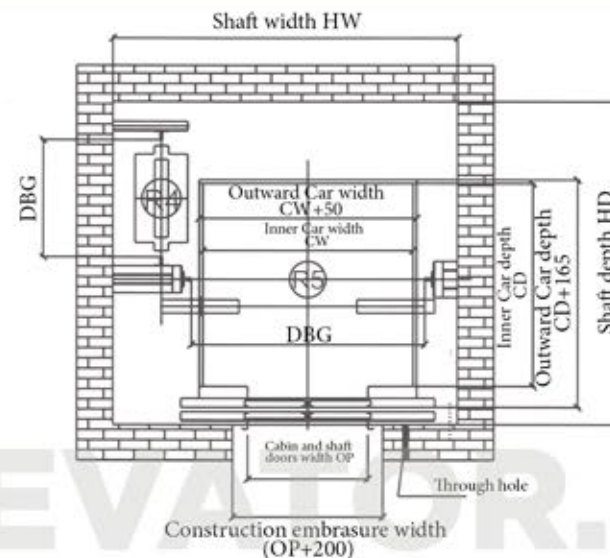

Model	Capacity, kg x passengers	Car dimension	Door Opening Width	Shaft dimension	Max. area, sq.m.
AMG PE450	450x6	1200x1050x2350	800x2100	2100x1900	1,3
AMG PE630	630x8	1400x1100x2350	800x2100	2250x2000	1,66
AMG PE800	800x10	1400x1350x2350	800x2100	2250x2100	2
AMG PE825	825x11	1400x1400x2350	800x2100	2250x2100	2,05
AMG PE1000	1000x13	1600x1450x2350	900x2100	2450x2200	2,4
AMG PE1050	1050x14	1600x1500x2350	900x2100	2450x2200	2,5
AMG PE1150	1150x15	1700x1500x2350	1000x2100	2550x2250	2,7
AMG PE1350	1350x18	1850x1600x2350	1100x2100	2850x2500	3,1
AMG PE1600	1600x21	2000x1700x2350	1100x2100	3000x2600	3,56

*FOR ALL MODELS DOOR OPENING TYPE: Center

SHAFT PLAN

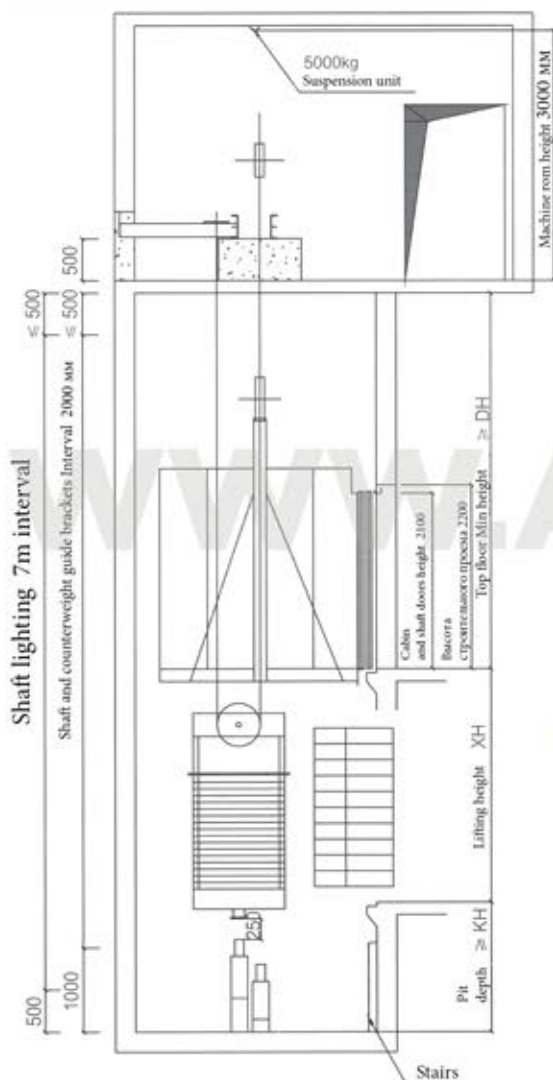

MACHINE ROOM ELEVATOR, Top view

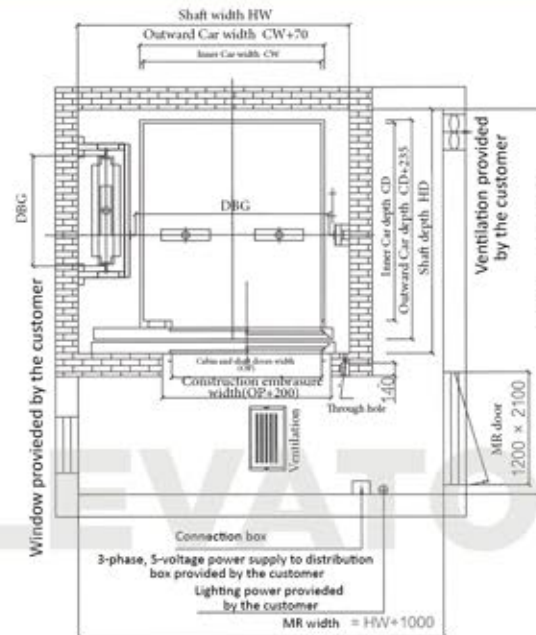

Model	Capacity, kg/passengers	Speed, m/s	Car dimension	Door Opening Type	Car & shaft doors width	Shaft dimension	Max. area, sq.m.
AMG C1000	1000	0,5	1400x1600x2200	Double folded	1200x2100	2300x2300	2,4
		1	1400x1500x2200				
AMG C2000	2000	0,5	1900x2100x2200	Double folded	1600x2100	2900x2800	4,2
		1	1900x2000x2200				
AMG C3000	3000	0,5	2200x2500x2200	Double folded	1800x2100	3400x3250	5,8
		1	2200x2450x2200				
AMG C5000	5000	0,5	2400x2650x2500	Double folded side open	2200x2400	3800x4350	9
		1	2400x3550x2500				

SHAFT PLAN

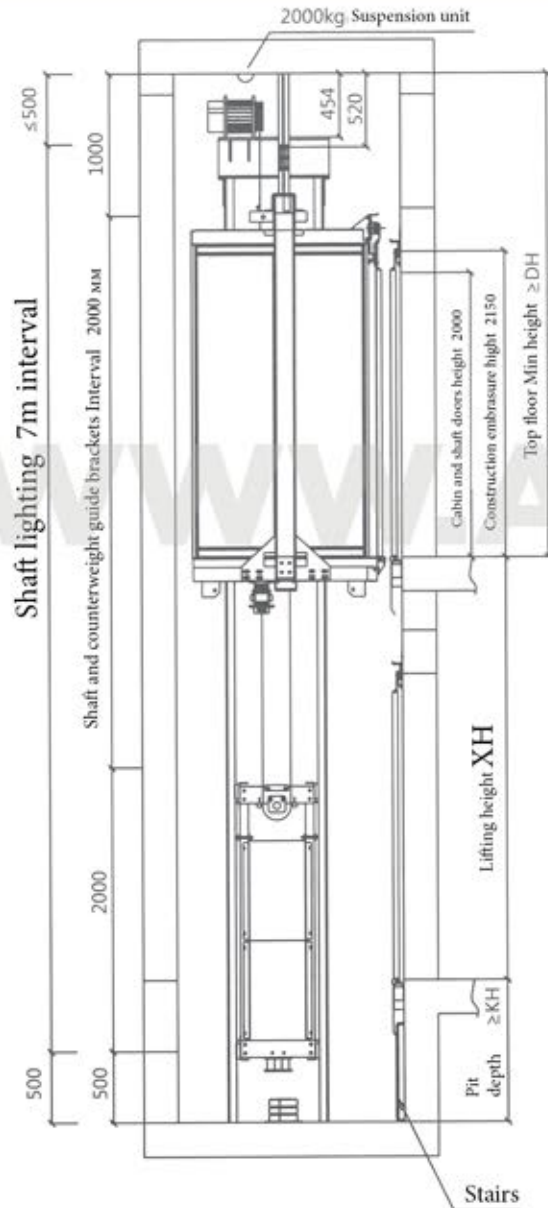

SHAFT DRAFT

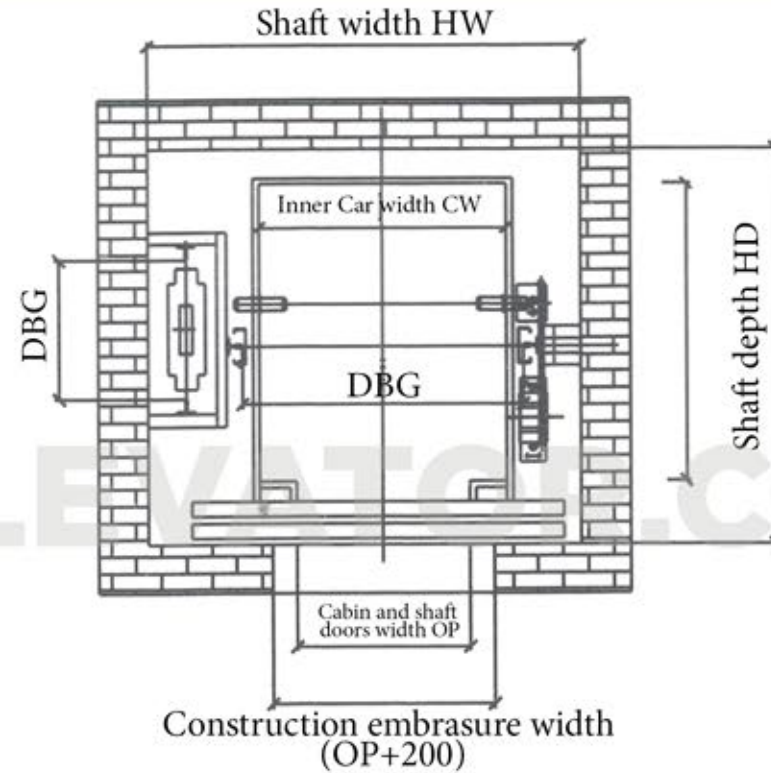

Model	Speed, m/s	Car dimension	Door Opening Width	Car & shaft doors width	Shaft dimension
AMG CE250	0,4	1000x800	700x2000	700x2000	1600x1200
AMG CE320	0,4	1000x1000	700x2000	700x2000	1600x1400
AMG CE400	0,4	1000x1200	700x2000	700x2000	1600x1600
AMG CE400	0,4	1200x1000	800x2000	800x2000	1800x1400

*** FOR ALL MODELS:**
 Pit depth ≥ 500
 Top floor Min height ≥ 3100

SHAFT PLAN

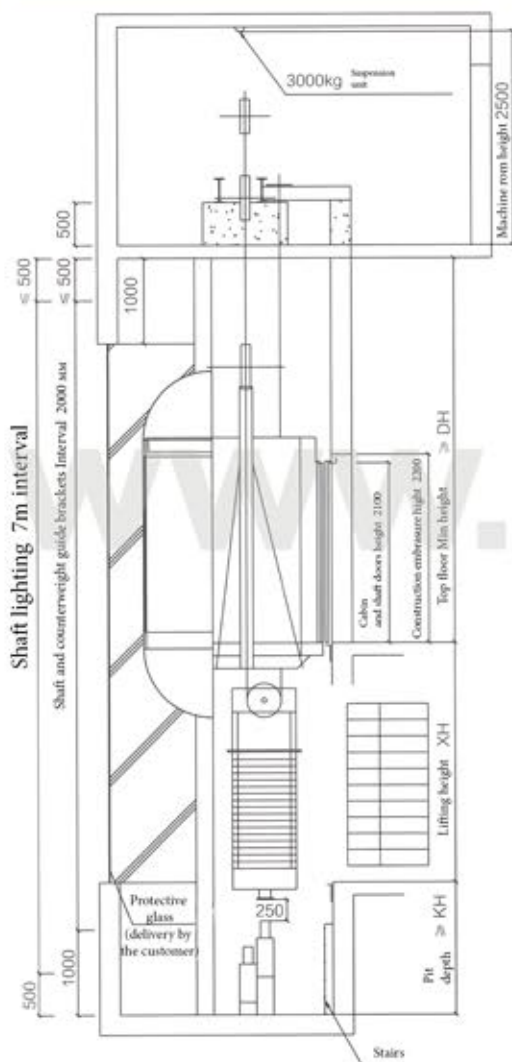

SHAFT DRAFT

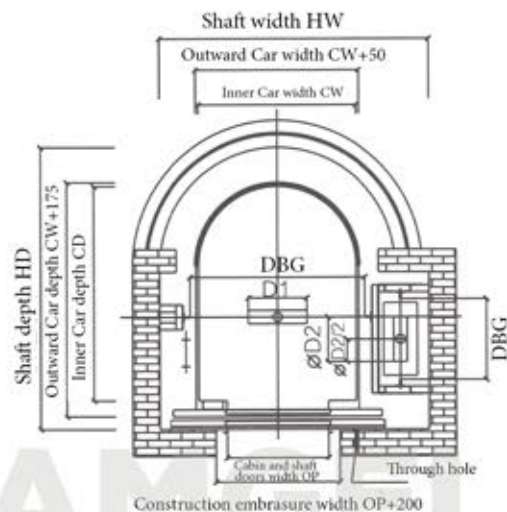

MACHINE ROOM DRAFT

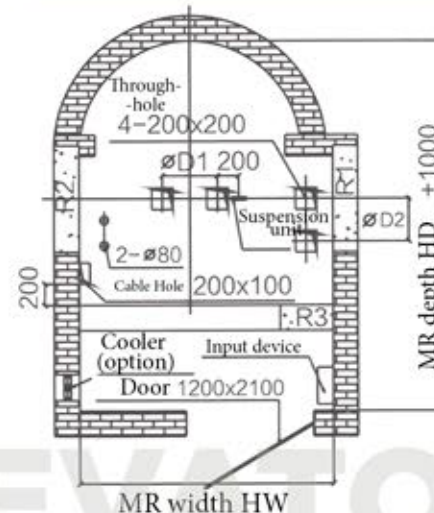

MACHINE ROOM SCHEME

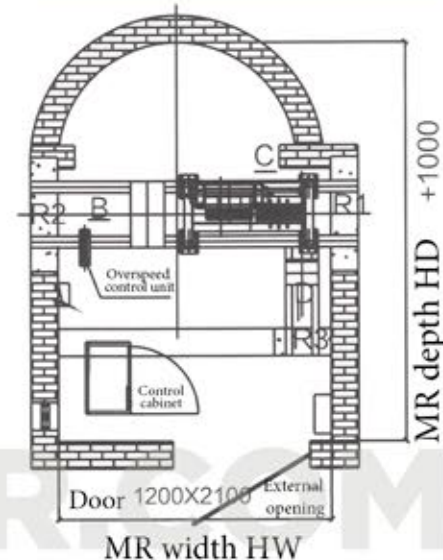

Model	Capacity, kg x passengers	Car dimension	Door Opening Type	Car & shaft doors width	Shaft dimension	Max. area, sq.m.
AMG PE800	800x10	1300x1700x2350	Center	800x2100	2300x2300	2
AMG PE1000	1000x13	1400x1900x2350	Center	900x2100	2400x2500	2,4
AMG PE1150	1150x15	1500x1900x2350	Center	900x2100	2500x2500	2,7
AMG PE1350	1350x18	1500x2150x2350	Center	900x2100	2500x2750	3,1
AMG PE1600	1600x21	1600x2200x2350	Center	1000x2100	2600x2800	3,56



SHAFT PLAN

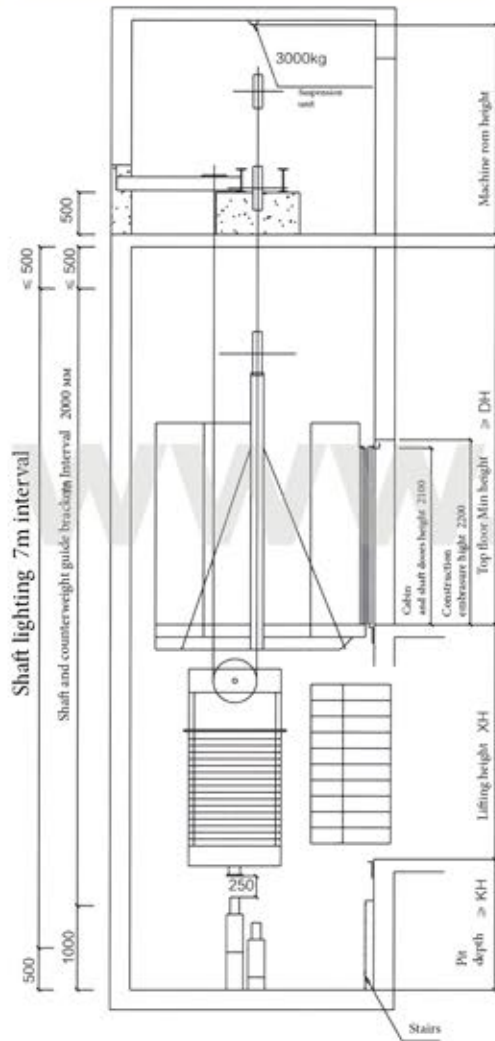

SHAFT DRAFT

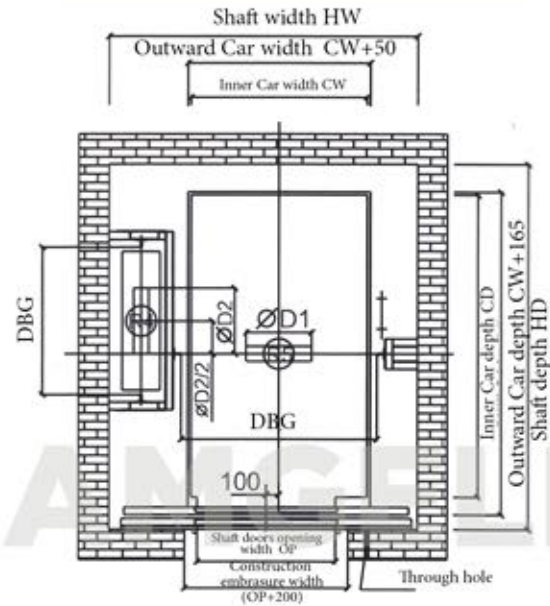

MACHINE ROOM DRAFT

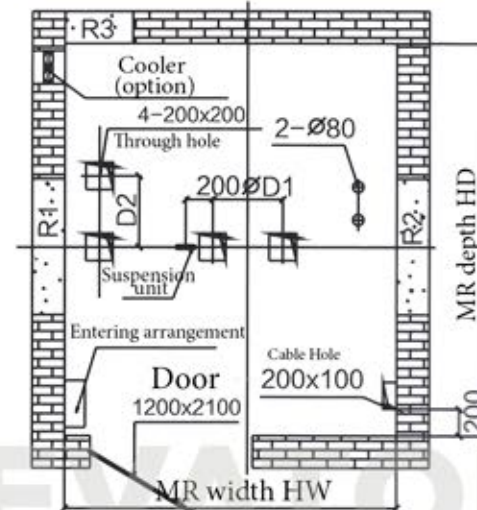

MACHINE ROOM SCHEME

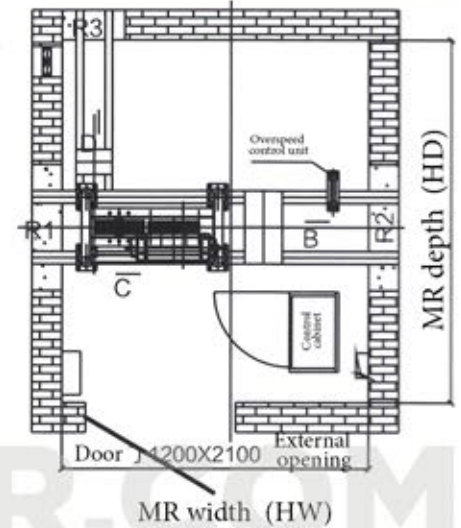

Model	Capacity, kg x passengers	Car dimension	Door Opening Type	Car & shaft doors width	Shaft dimension	Max. area, sq.m.
AMG ME1600	1600x21	1400x2400x2350	Center	1100x2100	2450x2900	3,56
AMG ME1600	1600x21	1400x2400x2350	Center	1200x2100	2450x2900	3,56

